

# SDR Slide Door Rail

## COMPONENTS



### SYSTEM FOR 1 1/2" and 3 1/2" COMBINATION WOOD/METAL and ALL METAL FRAMED SLIDE DOORS

#### SYSTEM STRENGTH

Heavy main wall on verticals combined with steel box girts increases overall strength in doors.

#### ATTRACTIVE APPEARANCE

Prefinished white aluminum verticals and bottom rails accent colored side-wall metal.

#### SYSTEM FLEXIBILITY

Various applications to choose from for maximum results with minimum inventory.

#### DESIGN COMPATIBILITY

Extra leg in "J" trim hides cut metal. Extra deep and extra wide nail/screw groove hides almost any fastener.

#### ENERGY EFFICIENT

Optional vinyl weather strip seals entire vertical to jamb.

# PLYCO

Due to Plyco Corporation's ongoing commitment to product improvement, we reserve the right to change, without notice, product specifications, availability, prices and conditions of sale.

PLYSdrLItpg1702



# System for Combination Wood/Metal & All-metal Framed Slide Doors

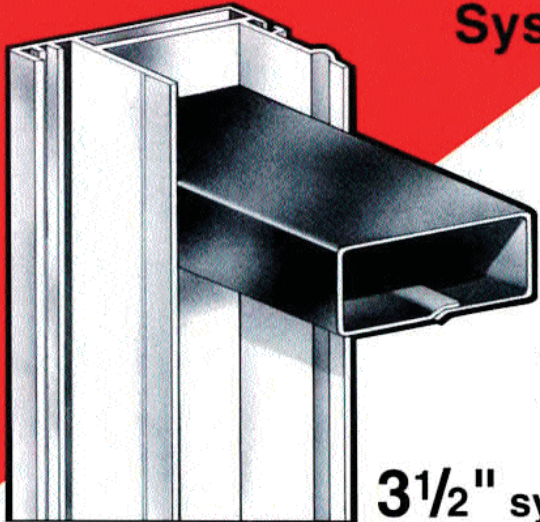

**3 1/2" system**

- Pre-finished white aluminum verticals
- Steel box girts
- All-metal guide systems

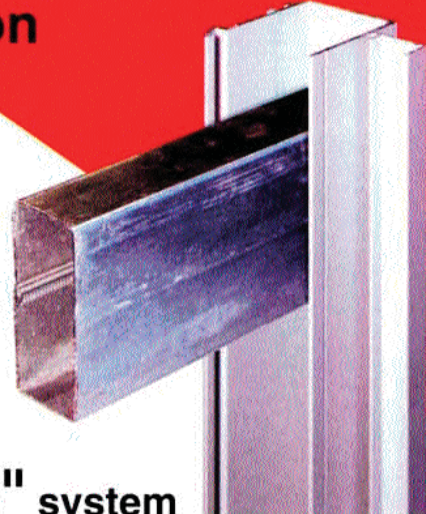

**1 1/2" system**

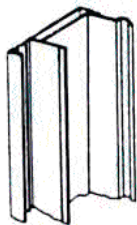

**SDR1635BV  
3 1/2" BOX VERTICAL**

- Built-in box extrusion gives best strength to weight ratio.
- Triple "J" Trim accepts vertically all metal heights.
- "J" for flat-cut metal extended and raised to allow easy insertion of sheet and conceals irregular cut.
- Optional weather strip available.
- Back designed not to catch on jamb trim while opening or closing door.
- Available 9, 10, 11, 12, 14, 15, 16, 18 & 20 foot lengths.

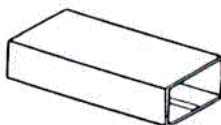

**SDR1635BG  
3 1/2" x 1 1/2" BOX GIRT**

- Lock seam tube for best economy, strength, and weight.
- 20 gauge steel G90 galvanized.
- Available in 10, 11, 12, 13'6", 14, 15, 16, 18, 20, 24 foot lengths.

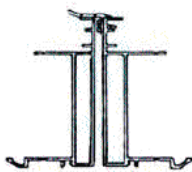

**SDR1635BC  
BOX VERTICAL CLOSURE**

- Designed to close the gap between the center of double doors.
- 16' lengths only.

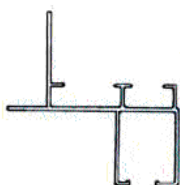

**SDR1635BB  
WHITE ALUMINUM  
3 1/2" BOX  
BOTTOM RAIL**

- (10', 12', 13'6", 14', 15', 16', 18', 20', 24')
- Mates w/SDR1635BV to complete an all-white 3 1/2" application.

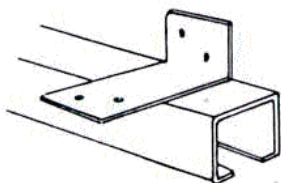

**SDR1635BR BOTTOM RAIL**

- Dual purpose - attaches to wood or steel girt.
- 18 gauge steel.
- Bottom rail channel mates w/guide rail system.
- Available 8', 10', 12' lengths.

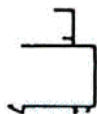

**SDR1600AV  
VERTICAL RAIL**

- High nail/screw groove protects jamb.
- Wide nail/screw groove allows nailing without damaging vertical.
- Optional vinyl weather strip wipes against jamb to seal opening.
- Designed to allow easier insertion of girts.
- Available 8, 9, 10, 11, 12, 13, 14, 15, 16, and 18 foot heights.



**SDR1600HC "H"  
CLOSURE**

- Simplifies stock.
- Closes gap between and strengthens center of double doors.
- Positive weather seal of door center with optional weather strip.
- Available 10, 12, 14 & 16 foot heights.

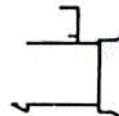

**SDR1600HV "H"  
VERTICAL RAIL**

- Economy of including "H" on standard vertical.
- Mates with standard vertical to hold double doors together.
- Positive weather seal of door center with optional weather strip.
- Available 10, 12, 14, 16 and 18 foot heights.



**SDR1600AB  
ALUMINUM  
BOTTOM RAIL**

- Trims bottom of door.
- Use with door roller.
- 10, 12, 14, 16 & 20 foot lengths - can be spliced.



**SDR1635BG  
1 1/2" x 3 1/2" BOX GIRT**

- Lock seam tube for best economy, strength and weight.
- 20 gauge steel, G90 galvanized.
- Available in 10, 11, 12, 13'6", 14, 15, 16, 18, 20, 24 foot lengths.

**SDR1600WB BOTTOM RAIL**

- Continuous nail flange can be cut any length.
- Designed with 1/4" up/down play to compensate for seasonal changes in door and building.
- Dual purpose - Use on wood doors (illus. A). Use on metal doors (illus. B). Nail to wood bottom rail or screw to aluminum vertical rail.
- 10', 12', 14', 16', 18' & 20' lengths help when door opening is full foot wide.

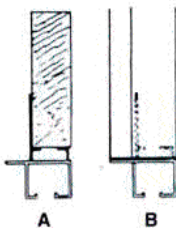
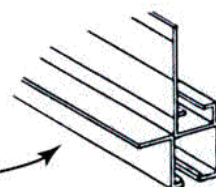

**SDR0500GZ-5'  
SDR1000GZ-10'** GUIDE RAIL

- Heavy galvanized steel.
- 5' & 10' lengths - use length or lengths equal to 1/3 - 1/2 the door panel width or more if desired.
- Bracket mounting hole located to allow lead in when door is closed and to aid in installation over metal or other obstruction.
- Holds door down and in.

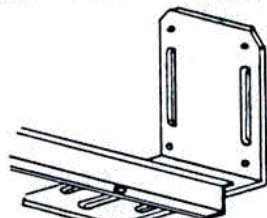

Note: Guide System is designed to give 4/4" of in/out and 2/4" of up/down adjustment.

**GUIDE RAIL SYSTEM**

- Designed to provide easy adjustment by building crew or user.
- Provides large amount of adjustment.

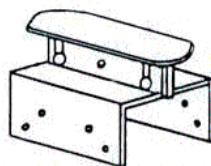

**SDR1601CG CENTER GUIDE**

- Heavy galvanized steel.
- Attaches on stub post or in cement in center of split doors & large singles.
- Removable stop prevents door from rolling past center.
- Mates w/SDR1635BR bottom rail for 3 1/2" system & SDR 1600WB bottom rail for 1 1/2" system.

**OPTIONS**

**SDR1600 WS  
WEATHER STRIPPING**

Optional vinyl weather strip seals entire vertical to jamb.

See **COMBO** catalog sheet for track, trolley & hardware products.

**PLYCO**  
CORPORATION

Elkhart Lake, Wisconsin 53020

USA  
800-558-5895  
Fax 800-257-5926

INTERNATIONAL  
414-876-3611  
Fax 414-876-3527

Distributed by: